

BALLEND HEX KEY

Set 9 pcs (Chrome)

Model No	Amm	Bmm	Cmm	Lmm		Price - ₹
BS-C9	50	42	65	120		576.00
BM-C9	50	42	65	183	mm 1.5, 2, 2.5, 3, 4, 5, 6, 8, 10	651.00
BL-C9	50	42	65	235	Inch 1/16, 5/64, 3/32, 1/8, 5/32,	752.00
BM-C9IN (In)	50	42	65	83	3/16, 1/4, 5/16, 3/8	740.00
BL-C9IN	50	42	65	235		841.00

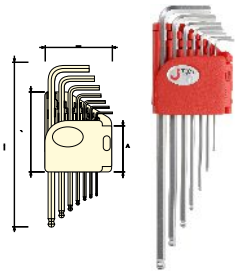

BALLEND HEX KEY

Set 7 pcs (Chrome)

Model No	Amm	Bmm	Cmm	Lmm		Price - ₹
BS-C7	40	57	63	95		358.00
BM-C7	40	57	63	142	mm 1.5, 2, 2.5, 3, 4, 5, 6	409.00
BL-C7	40	57	63	186		466.00

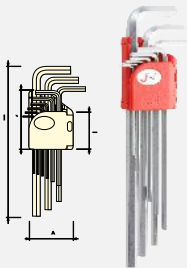

FLATEND HEX KEY

Set 9 pcs (Chrome)

Model No	Amm	Bmm	Cmm	Lmm		Price - ₹
PS-C9	50	42	65	120		501.00
PM-C9	50	42	65	163	mm 1.5, 2, 2.5, 3, 4, 5, 6	538.00
PL-C9	50	42	65	235	8, 10	651.00
PM-C9IN (In)						538.00
PL-C9IN (In)						651.00

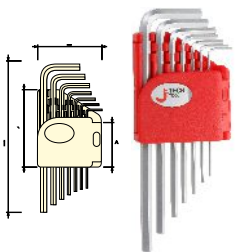

FLATEND HEX KEY

Set 7pcs (Chrome)

Model No	Amm	Bmm	Cmm	Lmm		Price - ₹
PS-C7	40	57	63	95		293.00
PM-C7	40	57	63	142	mm 1.5, 2, 2.5, 3, 4, 5, 6	330.00
PL-C7	40	57	63	186		381.00



TAMPER PROOF TORX L - KEY

Set (Chrome Plated)

Model No	Amm	Bmm	Cmm	Dmm		Price - ₹
SWS-8	25	35	37	70	SWS-8 TT5, TT6, TT7, TT8, TT9, TT10, TT15, TT20.	589.00
SWM-9	38	49	54	175	SWM-9 TT10, TT15, TT20, TT25, TT27, TT30, TT40, TT45, TT50	802.00



SINGLE HEX KEY

Short ball point chrome plated

Model No	A-Bmm	Price - ₹
BS-1.5C	45-14	35.00
BS-2C	50-16	35.00
BS-2.5C	56-18	38.00
BS-3C	63-20	40.00
BS-4C	70-25	52.00
BS-5C	80-28	62.00
BS-6C	90-32	74.00
BS-8C	100-36	117.00
BS-10C	112-40	152.00

SINGLE HEX KEY

Long ball point chrome plated



Model No	A-Bmm	Price - ₹
BM-1.5C	74-14	40.00
BM-2C	80-16	42.00
BM-2.5C	87-18	45.00
BM-3C	96-20	47.00
BM-4C	107-25	62.00
BM-5C	120-28	66.00
BM-6C	136-32	76.00
BM-7C	145-34	93.00
BM-8C	154-36	128.00
BM-10C	172-40	171.00
BM-12C	192-45	383.00
BM-14C	212-56	536.00
BM-16C	226-61	769.00
BM-17C	236-63	800.00
BM-18C	255-65	991.00
BM-19C	260-70	1,181.00
BM-22C	275-80	1,669.00

SINGLE HEX KEY

Extra Long ball point chrome plated



Model No	A-Bmm	Price - ₹
BL-1.5C	79-14	47.00
BL-2C	95-116	50.00
BL-2.5C	110-18	52.00
BL-3C	126-20	52.00
BL-4C	142-25	66.00
BL-5C	160-28	76.00
BL-6C	180-32	88.00
BL-8C	200-36	155.00
BL-10C	224-40	219.00
BL-12C	250-45	440.00
BL-14C	280-56	624.00
BL-17C	320-63	970.00
BL-19C	360-70	1,408.00

SINGLE HEX KEY

Short flat Chrome Plated



Model No	A-Bmm	Price - ₹
PS-1.5C	45-14	21.00
PS-2C	50-16	23.00
PS-2.5C	56-18	26.00
PS-3C	63-20	31.00
PS-4C	70-25	35.00
PS-5C	80-28	40.00
PS-6C	90-32	62.00
PS-8C	100-36	95.00
P5-10C	112-40	131.00

SINGLE HEX KEY

Long flat Chrome Plated



Model No	A-Bmm	Price - ₹
PM-1.5C	74-14	23.00
PM-2C	80-16	26.00
PM-2.5C	87-18	28.00
PM-3C	96-20	33.00
PM-4C	107-25	42.00
PM-5C	120-28	50.00
PM-6C	136-32	69.00
PM-8C	154-36	114.00
PM-10C	172-40	162.00
PM-12C	192-45	317.00
PM-14C	212-56	459.00
PM-16C	226-61	671.00
PM-17C	236-63	684.00
PM-18C	255-65	854.00
PM-19C	260-70	900.00
PM-22C	275-80	1,277.00
PM-24C	305-90	1,400.00
PM-27C	320-100	2,111.00
PM-32C	370-125	3,130.00
PM-36C	405-140	4,202.00

SINGLE HEX KEY

Extra long flat chrome plated



Model No	A-Bmm	Price - ₹
PL-1.5C	78-14	27.00
PL-2C	95-16	27.00
PL-2.5C	110-18	34.00
PL-3C	126-20	39.00
PL-4C	142-25	45.00
PL-5C	160-28	60.00
PL-6C	190-32	84.00
PL-8C	200-35	143.00
PL-10C	224-40	215.00
PL-12C	250-45	386.00
PL-14C	280-56	548.00
PL-17C	320-63	858.00
PL-19C	360-70	1,182.00

SHORT HEX KEY SET

Made of the premium alloy steel, it gets high torsion and hardness after the heat treatment.



Model No	mm	Price - ₹
KW-9	1.5 2 2.5 3 4 5 6 8 10	267.00

FOLDING HEX KEY SET

Made of the premium alloy steel, it gets high torsion and hardness after the heat treatment.



Model No	Amm	Bmm	Cmm	Lmm		Price - ₹
FD-8	116	25	30	120	FD-8 2.0 2, 3.0 4.0 5.0 5, 6.0 8.0	438.00
FD-9					FD-9 1.5 2.0 2.5 3.0 4.0 5.0 5.5 6.0 8.0	461.00
FT-9					FT-9 T6,T9,T10,T15,T20,T25	576.00

BALLEND HEX DRIVER



Model No	Amm	Bmm	Dmm	Pmm	Lmm	Price - ₹
HLC1.5-110	1.5	1.65	16	110	170	72.00
HLC2-110	2	2.20	16	110	170	75.00
HLC2.5-120	2.5	2.78	16	120	180	77.00
HLC3-120	3	3.35	16	120	180	80.00
HLC4-120	4	4.50	20	120	200	100.00
HLC5-130	5	5.62	24	130	220	125.00
HLC6-150	6	6.75	26	150	245	160.00
HLC8-200	8	9.05	28	200	300	250.00
HLC10-200	10	11.30	30	200	306	303.00

13 PCS HEX KEY SET BALLEND

Made of the premium alloy steel, it gets high torsion and hardness after the heat treatment.

The ball end part is specially designed to be used under the inclined 25



Model No	mm	Price - ₹
BM-C13	1.5 2 2.5 3 4 5 6 8 10 12 14 17 19	3,177.00

T-TYPE HEX DRIVER PLATED FLAT HEAD

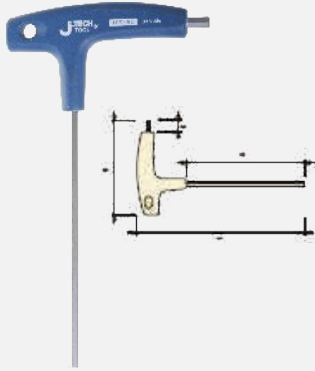

Model No	Amm	Bmm	Cmm	Lmm	Price - ₹
TPS-2C	100	85	10	145	144.00
TPS-2.5C	100	85	10	145	150.00
TPS-2.5C	200	85	10	245	160.00
TPS-3C	100	85	10	145	156.00
TPS-3C	200	85	10	245	165.00
TPS-4C	125	100	10	178	221.00
TPS-4C	200	100	10	278	230.00
TPS-5C	125	100	10	178	246.00
TPS-5C	200	100	10	278	260.00
TPS-6C	150	122	15	212	297.00
TPS-8C	180	122	15	244	394.00
TPS-10C	180	122	18	244	500.00
TPS-3/32"C					150.00
TPS-1/8"C					160.00
TPS-5/32"C					221.00
TPS-3/16"C					250.00
TPS-1/4"C					300.00
TPS-5/16"C					400.00



T-TYPE HEX DRIVER PLATED BALL HEAD

Model No	Amm	Bmm	Cmm	Lmm	Price - ₹
TBS-2C	100	85	10	145	153.00
TBS-2.5C	100	85	10	145	158.00
TBS-3C	100	85	10	145	164.00
TBS-4C	125	100	10	178	231.00
TBS-5C	125	100	10	178	256.00
TBS-6C	150	122	15	212	311.00
TBS-8C	180	122	15	244	404.00
TBS-10C	180	122	18	244	514.00



METRIC T TYPE HEX DRIVER SET 7PCS

Model No	Price - ₹
TPS-7S	1710.00

TPS-2C, TPS-2C.5, TPS-3C, TPS-4C, TPS-5C, TPS-6C, TPS-8C

TESTER



Model No	A-mm	L-mm	Price - ₹
VT-140	18	140	58.00



6 PCS SET



SOFTGRIP SCREWDRIVER SET

Model No	Contents	Price - ₹
ST-6S	ST4-75 ST5-100 ST6-150	58.00

⊕ ⊖ 10 PCS SET



SOFTGRIP SCREWDRIVER SET 10pcs

Model No	Contents	Price - ₹
ST-10S	⊕ ⊖ ST4-75 ⊕ ⊖ ST5-100 ⊕ ⊖ ST6-25 ⊕ ⊖ ST6-150 ⊕ ⊖ ST8-150	1710.00

⊕ ⊖



PLASTIC HANDLE PRECISION SCREWDRIVER 6PCS SET

- Using nickel chrome vanadium steel
- Screwdriver head after precision machining, make it more joint screw pitch, to maximize the torque
- The overall quenching, achieve high hardness, high torque, more durable
- Batch head head is made of super precision machining, with a small screw can also be very tight
- Easy handling small screws

Model No	Contents	Price - ₹
PES-S6	⊕ ⊖ 1.4mm 1.8mm 2.5mm ⊕ ⊖ #00 #0 #1	437.00

⊕ ⊖



PRECISION SCREWDRIVER SET

- Using nickel chrome vanadium steel
- Screwdriver head after precision machining, make it more joint screw pitch, to maximize the torque
- The overall quenching, achieve high hardness, high torque, more durable
- Batch head is made of super precision machining, with a small screw can also be very tight
- Easy handling small screws

Model No	Contents	Price - ₹
PE-S	⊕ ⊖ 1.0mm 1.2mm 1.6mm ⊕ ⊖ #00 #0 #1	284.00
PE-M	⊕ ⊖ 1.4mm 1.8mm 2.5mm ⊕ ⊖ #00 #0 #1	314.00

⊕ ⊖

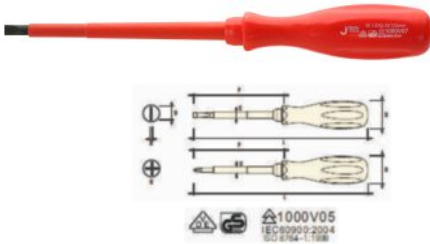

INSULATED 1000V SCREWDRIVERS

Model No	A-Bmm	Cmm	Dmm	Pmm	Lmm	Price - ₹
IS2.5-75 ⊖	0.4-2.5	4.2	24	75	152	125.00
IS4.0-100 ⊖	0.8-4.0	5.8	26	100	185	150.00
IS5.5-125 ⊖	1.0-5.5	7.3	28.5	125	220	180.00
IS6.5-150 ⊖	1.2-6.5	8.3	28.5	150	246	215.00
IS#0-75 ⊕	#0	5	24	75	152	125.00
IS#1-80 ⊕	#1	6.5	26	80	160	150.00
IS#2-100 ⊕	#2	8	28.5	100	195	192.00

⊕ ⊖ 8 PCS SET



INSULATED SCREWDRIVER SET 8PCS (1000 V)

Model No	Contents	Price - ₹
IS-8S	2.5-75 4.0-100 5.5-125 6.5-150 #0-75 #1-80 #2-100	1,447.00

LINE COLOUR SCREWDRIVER (Slotted & Philips Same Price)



Model No	A-Bmm	Cmm	Dmm	Pmm	Lmm	Price - ₹
LC2.5-50 ⊕⊖	0.4-2.5	2.5	14	50	100	63.00
LC2.5-75 ⊕⊖	0.4-2.5	2.5	14	75	125	66.00
LC3-50 ⊕⊖	0.6-3.3	3.3	15	50	107	63.00
LC3-75 ⊕⊖	0.6-3.3	3.3	15	75	132	64.00
LC3-100 ⊕⊖	0.6-3.3	3.3	15	100	157	66.00
LC3-150 ⊕⊖	0.6-3.3	3.3	15	150	207	67.00
LC3-200 ⊕⊖	0.6-3.3	3.3	IS	200	257	74.00
LC3-250 ⊕⊖	0.6-3.3	3.3	IS	200	257	85.00
LC3-300 ⊕⊖	0.6-3.3	3.3	IS	200	257	85.00
LC5-75 ⊕⊖	0.8-5.0	4.7	20	75	155	82.00
LC5-100 ⊕⊖	0.8-5.0	4.7	20	100	180	83.00
LC5-125 ⊕⊖	0.8-5.0	4.7	20	125	205	87.00
LC5-150 ⊕⊖	0.8-5.0	4.7	20	150	230	91.00
LC5-200 ⊕⊖	0.8-5.0	4.7	20	200	280	95.00
LC5-250 ⊕⊖	0.8-5.0	4.7	20	250	330	98.00
LC5-300 ⊕⊖	0.8-5.0	4.7	20	300	390	131.00
LC6-40 ⊕⊖	1.0-5.0	6.0	24	75	165	81.00
LC6-75 ⊕⊖	1.0-5.0	6.0	24	75	165	89.00
LC6-100 ⊕⊖	1.0-6.0	6.0	24	100	190	97.00
LC6-125 ⊕⊖	1.0-6.0	6.0	24	125	215	100.00
LC6-150 ⊕⊖	1.0-6.1	6.0	24	150	240	109.00
LC6-200 ⊕⊖	1.0-6.0	6.0	24	200	290	114.00
LC6-250 ⊕⊖	1.0-6.0	6.0	24	250	340	118.00
LC6-300 ⊕⊖	1.0-6.0	6.0	24	300	390	131.00
LC8-150 ⊕⊖	1.2-8.0	8.0	28	150	250	150.00
LC8-200 ⊕⊖	1.2-8.0	8.0	28	200	280	179.00
LC8-250 ⊕⊖	1.2-8.0	8.0	28	250	330	183.00
LC8-300 ⊕⊖	1.2-8.0	8.0	28	300	390	200.00

SOFTGRIP SCREWDRIVER (Slotted & Philips Same Price)



Model No	A-Bmm	Cmm	Dmm	Pmm	Lmm	Price - ₹
ST4-50 ⊕⊖	0.7-4	4	24	50	139	93.00
ST4-75 ⊕⊖	0.7-4	4	24	75	164	102.00
ST4-100 ⊕⊖	0.7-4	4	24	100	189	106.00
ST4-125 ⊕⊖	0.7-4	4	24	125	214	109.00
ST4-150 ⊕⊖	0.7-4	4	24	150	289	111.00
ST4-200 ⊕⊖	0.7-4	4	24	200	289	117.00
ST5-25 ⊕⊖	0.8-5	5	33	75	172	106.00
ST5-75 ⊕⊖	0.8-5	5	33	75	172	125.00
ST5-100 ⊕⊖	0.8-5	5	33	100	197	131.00
ST5-125 ⊕⊖	0.8-5	5	33	125	222	142.00
ST5-150 ⊕⊖	0.8-5	5	33	150	247	148.00
ST5-200 ⊕⊖	0.8-5	5	33	200	297	153.00
ST6-25 ⊕⊖	0.8-5	5	33	75	172	114.00
ST6-100 ⊕⊖	1.0-6	6	36	100	205	142.00
ST6-125 ⊕⊖	1.0-6	6	36	125	230	153.00
ST6-150 ⊕⊖	1.0-6	6	36	150	255	159.00
ST6-200 ⊕⊖	1.0-6	6	36	200	305	167.00
ST6-250 ⊕⊖	1.0-6	6	36	250	355	175.00
ST6-300 ⊕⊖	1.0-6	6	36	300	405	203.00
ST8-150 ⊕⊖	1.2-8	8	38	150	283	203.00
ST8-200 ⊕⊖	1.2-8	8	38	201	200	237.00
ST8-250 ⊕⊖	1.2-8	8	38	250	363	273.00
ST8-300 ⊕⊖	1.2-8	8	38	300	397	300.00

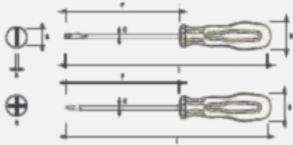

ACETATE HANDLE SCREWDRIVERS (PRO QUALITY) (Star & Flat Same Price)

- The screwdriver shaft is made of CR-V Nickel steel
- The handle is made of acetate material, with the features such as high hardness, high temperature resistance, impact resistance and good transparency.
- The design of the handle is customized according to the Asians' hand shape to grip more comfortably.
- Standard: GB/T 10635-2003

Model No	A-Bmm	Cmm	Dmm	Pmm	Lmm	Price - ₹
AC3-75 ⊕⊖	#0	3.3	23	75	147	163.00
AC3-100 ⊕⊖	#0	3.3	23	100	172	167.00
AC3-150 ⊕⊖	#0	3.3	23	150	222	174.00
AC5-75 ⊕⊖	#1	4.7	27	75	165	234.00
AC5-100 ⊕⊖	#1	4.7	27	100	190	239.00
AC5-150 ⊕⊖	#1	4.7	27	150	240	250.00
AC5-200 ⊕⊖	#2	4.7	27	200	290	259.00
AC6-100 ⊕⊖	#2	6.0	32	100	200	306.00
AC6-150 ⊕⊖	#2	6.0	32	150	250	319.00
AC6-200 ⊕⊖	#2	6.0	32	200	300	331.00
AC6-250 ⊕⊖	#2	6.0	32	250	350	347.00
AC6-300 ⊕⊖	#2	6.0	32	300	400	359.00
AC8-150 ⊕⊖	#3	8.0	35	150	260	418.00
AC8-200 ⊕⊖	#3	8.0	35	200	310	438.00
AC8-250 ⊕⊖	#3	8.0	35	250	360	457.00
AC8-300 ⊕⊖	#3	8.0	35	300	410	464.00



9PCS SCREWDRIVERS SET

- The screwdriver shaft is made of CR-V nickel steel
- The screwdriver shaft is made split design to carry conveniently, and it's the Family prerequisite products.

Model No	Contents	Price - ₹
FM-LH (Medium)	⊖ 3mm, ⊖ 5mm, ⊖ 6mm, ⊕ PULLER ⊕ NO.0 ⊕ NO.1 ⊕ NO.2 ⊗ AWL SQ	627.00

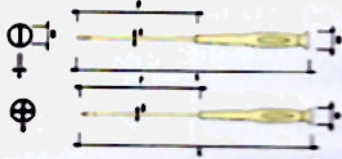

PRECISION SCREWDRIVERS (Slotted & Philips Same Price)

- Using nickel chrome vanadium steel
- Screwdriver head after precision machining, make it more joint screw pitch, to maximize the torque
- The overall quenching, achieve high hardness, high torque, more durable
- Batch head is made of super precision machining, with a small screw can also be very tight Easy handling small screws

Model No	A-Bmm	Cmm	Dmm	Pmm	Lmm	Price - ₹
PES2.5-50 ⊖	0.35-2.5	2.5	18	50	145	85.00
PES2.5-75 ⊖	0.35-2.5	2.5	18	75	170	90.00
PES3-100 ⊖	0.45-3.0	3.0	18	100	195	95.00
PES3-150 ⊖	0.45-3.0	3.0	18	150	245	95.00
PES2.5-50 ⊕	#00	2.5	18	50	145	85.00
PES2.5-75 ⊕	#00	2.5	18	75	170	90.00
PES3-100 ⊕	#0	3.0	18	100	195	95.00
PES3-150 ⊕	#0	3.0	18	150	245	95.00



SOFTGRIP NUTDRIVER

Model No	A-Bmm	Cmm	Dmm	Pmm	Lmm	Price - ₹
SD4-125 ●	7-4	7	36	125	235	282.00
SD5-125 ●	8-5	7	36	125	235	287.00
SD5.5-125 ●	9-5.5	7	36	125	235	287.00
SD7-125 ●	10-7	7	36	125	235	295.00
SD8-125 ●	12-8	7	36	125	235	311.00
SD10-125 ●	14-10	7	36	125	235	319.00
SD13-125 ●	18-13	8	38	125	245	381.00



LINE COLOUR NUTDRIVER

Model No	A-Bmm	Cmm	Dmm	Pmm	Lmm	Price - ₹
LD4-115	8-4	6	28	115	210	183.00
LD5.5-115	8-5	6	28	115	210	188.00
LD6-115	10-6	6	28	115	210	188.00
LD7-115	11-7	6	28	115	210	190.00
LD8-115	11-8	7	28	115	210	192.00
LD10-115	13-10	7	28	115	210	204.00



LINE COLOUR TORX SCREWDRIVER

Model No	A-Bmm	Cmm	Dmm	Pmm	Lmm	Price - ₹
EC-T5	T5	3	14	75	125	76.00
EC-T6	T6	3	14	75	125	76.00
EC-T7	T7	3	14	75	125	76.00
EC-T8	T8	4	16	75	148	84.00
EC-T9	T9	4	16	75	148	84.00
EC-T10	T10	4	20	75	155	99.00
EC-T15	T15	4	20	100	180	105.00
EC-T20	T20	2	24	100	190	122.00
EC-T25	T20	2	24	100	190	131.00
EC-T30	T20	2	24	100	190	139.00



LINE COLOUR TAMPER PROOF TORX SCREW DRIVERS

Model No	A-Bmm	Cmm	Dmm	Pmm	Lmm	Price - ₹
EC-TT6	T6	3	14	75	125	83.00
EC-TT7	T7	3	14	76	125	83.00
EC-TT8	T8	4	16	75	148	91.00
EC-TT9	T9	4	16	75	148	91.00
EC-TT10	T10	5	20	75	155	110.00
EC-TT15	T15	5	20	100	180	113.00
EC-TT20	T20	6	24	100	190	129.00
EC-TT25	T25	6	24	100	190	133.00
EC-TT30	T30	6	24	150	240	143.00



SOFTGRIP TORX SCREWDRIVERS TAMPER PROOF

Model No	A-Bmm	Cmm	Dmm	Pmm	Lmm	Price - ₹
TTX-10-75	T10	5	33	75	172	147.00
TTX-15-75	T15	5	33	75	172	147.00
TTX-20-100	T20	6	36	100	205	163.00
TTX-25-100	T25	6	36	100	205	163.00
TTX-30-125	T30	6	36	125	230	165.00
TTX-40-150	T40	8	38	150	263	205.00



6 IN 1 SCREWDRIVER

- The screwdriver shaft is made of CR-V nickel steel.
- Patented product, carry convenient, assembled with six different types of screwdrivers.
- The handle is made of the mixture of the high tenacity nylon and the glass fiber

Model No	Contents	Price - ₹
SI-107	⊖4mm ⊖5mm ⊖6mm ⊕#1 ⊕#2 ⊕#3	865.00



2-WAY SOFTGRIP SCREWDRIVER

Model No	A-Bmm	C	Dmm	Emm	Pmm	Pmm	Price - ₹
DST-100	1.0-6	#2	6.35	40	135	110	264.00
DST-150	1.0-6	#2	6.35	40	86	110	275.00
DST-200	1.0-6	#2	6.35	40	86	110	304.00



GO-THROUGH SCREWDRIVER

Model No	A-Bmm	Cmm	Dmm	Pmm	Lmm	Price - ₹
GTH6-200	1.0-6	6.35	34	200	310	293.00
GTH6-250	1.0-6	6.35	34	250	360	303.00
GTH8-300	1.0-6	7.93	38	300	420	459.00



2-WAY LINE COLOR SCREWDRIVER

Model No	A-Bmm	C	Dmm	Emm	Pmm	Pmm	Price - ₹
DLC6-40	1.0-6	#2	6.35	28	75	55	183.00
DLC-75	0000	00	000	00	00	000	220.00
DLC-100	0000	00	000	00	00	000	221.00
DLC-125	1.0-6	#2	6.35	26	160	105	225.00
DLC-150	00000	00	000	00	000	000	231.00

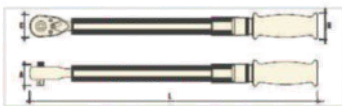

TORQUE WRENCHES

- Standard: GB/T14765-2008
- Long service life: Optimized gear structure enhance the durability and prolong the service life. Flexible regulator
- Convenience setting torsion: Pull out the locking ring when setting the torsion and release the ring when the torsion set.

Model No	A-Bmm	Cmm	Dmm	Pmm	Range	Price - ₹
TQW1/4-2-10	25	32	28	280	2-10Nm	8667.00
TQW1/4-4-20	25	32	28	320	4-20Nm	8667.00
TQW3/8-20-100	30	42	28	440	20-100Nm	10781.00
TQW1/2-40-200	40	41	43	510	40-200Nm	10,993.00
TQW1/2-60-340	40	41	43	615	60-340Nm	11,589.00
TQW3/4-150-800	50	41	62	1230	150-800Nm	44,835.00

NEEDLE FILE SET OF 5 and 10 Pcs



Model No	Amm	Bmm	Content	Price - ₹
MF-5A	78	183	5Pcs Set 140mm	266.00
MF-5B	85	205	5Pcs Set 160mm	325.00
MF-5C	86	222	5Pcs Set 180mm	403.00
MF 10A	150	180	10Pcs Set 140mm	440.00
MF-10B	167	202	10Pcs Set 160mm	557.00
MF-10C	195	224	10Pcs Set 180mm	734.00

DIAMOND NEEDLE FILE SET OF 3Pcs



Model No	Amm	Bmm	Content	Price - ₹
DF-3A	50	182	3Pcs Set 140mm	458.00
DF-3B	55	205	3Pcs Set 160mm	582.00
DF-3C	60	222	3Pcs Set 180mm	740.00

PU HAMMER

- The hammer can absorb the counterforce to be shockproof with the sand inside.
- Standard : GB/T 13473-2008



Model No	Specification Oz	Amm	Bmm	Lmm	Price - ₹
HDB-35	35	30	80	270	578.00
HDB-45	45	35	100	300	688.00
HDB-55	55	37	100	340	887.00
HDB-65	65	40	135	370	1,376.00

BALL PEIN HAMMER

- Fiber glass handle grip
- The head of hammer is forged by the premium medium carbon steel
- Processed by the special heat treatment at the base to make the base's intensity stronger than the body's intensity and reduce the counter force when knocking and reduce the harm of hand When Operating.



Model No	Specification Oz	Amm	Bmm	Lmm	Price - ₹
HBP-16	16(1lb)	30	105	340	522.00
HBP-24	24(1.5lb)	40	125	372	591.00
HBP-32	32(2lb)	40	132	375	631.00

RUBBER HAMMER

- The head is made of the rubber
- Wooden handle
- Apply to the working environment without any print, such as the decoration



Model No	Specification Oz	Amm	Bmm	Lmm	Price - ₹
HRW-8	8(0.51b)	30	80	310	161.00
HRW-12	12(0.75lb)	30	95	310	174.00
HRW-16	16(1lb)	30	95	317	227.00
HRW-24	24(1.5lb)	32	120	320	320.00

CLAW HAMMER

- Tiber glass handle grip
- The head of hammer is forged by the premium medium carbon steel
- Processed by the special heat treatment at the base to make the base's intensity stronger than the body's insity and reduce the counterforce when knocking and reduce the harm of hand when operating.
- Standard: GB/T 13473-2008



Model No	Specification Oz	Amm	Bmm	Lmm	Price - ₹
HCP-16	16	40	135	330	489.00
HCP-20	20	40	138	335	525.00
HCP-24	24	40	140	380	612.00



FEELER GAUGE 32PCS SET

Model No	Content mm	Price - ₹
FGS-32	0.02, 0.03, 0.04, 0.05, 0.10 0.15, 0.20, 0.25, 0.30, 0.35, 0.40, 0.45, 0.50, 0.55, 0.60, 0.65, 0.70, 0.75, 0.80, 0.85, 0.90, 0.95, 1.00	403.00



GREASE GUN (LEVER TYPE)

Model No	Amm	Bmm	Lmm	Price - ₹
GG-400	150	55	535	1,327.00



HOT GLUE GUN

Model No	Amm	Bmm	Price - ₹
HMG60-100	195	175	1,179.00



OIL FILTER BELT WRENCH

Model No	Amm	Bmm	Price - ₹
STW-9	19.5	225	684.00



MAGNETIC PICK UP TOOL

- Standard: Q/TKG 27-2011
- Function: Soft pipe, pick up accessories. steel and iron abducts at narrow spaces.

Model No	Amm	Lmm	Price - ₹
MPU-17	27	510	547.00



GEAR PULLER 2 LEGS

- The top head is heat treated and durable for using.
- The jaws are well designed to prevent falling off at use.
- Applicable to assemble and dismantle the ball bearing and wheel gear etc.

Model No	Amm	Bmm	Max mm	Min mm	Price - ₹
2GP-75	102	125	80	15	863.00
2GP-100	132	168	110	20	1198.00
2GP-150	212	212	160	25	1981.00
2GP-200	300	333	210	30	3452.00
2GP-250	353	333	265	40	6799.00
2GP-300	378	390	315	50	9727.00



GEAR PULLER 3 LEGS

- The top head is heat treated and durable for using.
- The jaws are well designed to prevent falling off at use.
- Applicable to assemble and dismantle the ball bearing and wheel gear etc.

Model No	Amm	Bmm	Max mm	Min mm	Price - ₹
3GP-75	102	125	80	5	1080.00
3GP-100	132	168	110	20	1498.00
3GP-150	212	212	160	25	2582.00
3GP-200	300	333	210	30	4502.00
3GP-250	353	333	265	40	8570.00
3GP-300	378	390	315	50	12258.00



HEAVY DUTY PIPE WRENCHES

- The top head is heat treated and durable for using.
- The jaws are well designed to prevent falling off at use.
- Applicable to assemble and dismantle the ball bearing and wheel gear etc.

Model No	Amm	Bmm	Cmm	Lmm	Price - ₹
PW-200 8"	11	22	15	200	406.00
PW-250 10"	12	25	18	250	477.00
PW-300 12"	14	30	20	300	700.00
PW-350 14"	16.5	36	23.5	350	890.00
PW-450 18"	20	45	25	450	1228.00
PW-600 24"	20	45	25	450	1862.00
PW-900 36"	20	45	25	450	3649.00



HAND RIVETER

Model No	Amm	Bmm	Price - ₹
HR-101	76	60	822.00



HAND RIVETER(Plier Type)

Model No	Bmm	Lmm	Price - ₹
HR-201	170	535	3,118.00

HAND RIVETER (Collapsible Type)



Model No	Price - ₹
HR-301	3,118.00

ADJUSTABLE WRENCH (Chrome Plated)

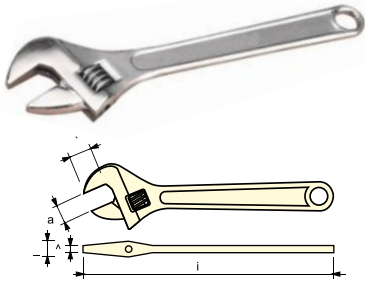

Model No	Amm	Bmm	Cmm	Dmm	Lmm	Price - ₹
AW-4	6.5	9.2	13.5	14.0	100	247.00
AW-6	8.3	12.0	20.0	20.0	150	259.00
AW-8	9.0	14.0	24.5	25.0	200	344.00
AW-10	9.5	16.0	30.0	30.0	250	452.00
AW-12	10.5	17.5	36.0	36.0	300	659.00
AW-15	12.8	22.0	47.0	46.0	375	1,280.00
AW-18	19.0	29.0	53.6	55.0	450	2,487.00
AW-24	21.0	33.5	67.	63.0	600	4,108.00
AW-30						19,015.00

SOFTGRIP ADJUSTABLE WRENCHES (Chrome Plated)

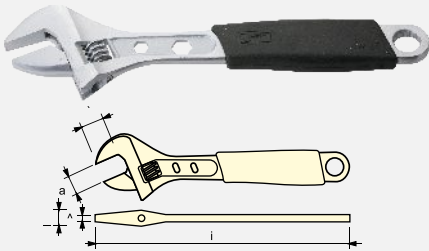

Model No	Amm	Bmm	Cmm	Dmm	Lmm	Price - ₹
AWS-6	6.5	10.3	20.5	20.0	150	394.00
AWS-8	7.8	12.5	26.0	28.0	200	483.00
AWS-10	8.5	14.5	32.0	30.0	250	627.00
AWS-12	9.7	17.71	37.0	40.0	300	849.00



DOUBLE END SPANNER SET

Model No	Content mm	Price - ₹
OWS-S8	6X7 8x9 10x11 12x13 14x15 16x17 18x19 20X22	1,790.00
OWS-S12	6X7 8x9 10X11 12x13 14x15 16X17 18X19 20X22 21X23 24X27 25X28 30x32	3,806.00



COMBINATION SPANNER SET

Model No	Content mm	Price - ₹
COM-S12	6 7 8 9 10 11 12 14 15 17 1617 18 19	3,203.00
COM-S26	6 7 8 9 10 11 12 13 14 15 1 6 17 18 19 20 21 22 23 24 25 26 27 28 29 30 32	7,725.00



COMBINATION RING RATCHET SET

Model No	Content mm	Price - ₹
GR-S12	8 9 10 11 12 13 14 15 16 17 18 19	7436.00
GR-S20	6 7 8 9 10 11 12 13 14 15 16 17 18 19 21 22 24 27 30 32	16,946.00

COMBINATION SPANNER



Model No	Amm	Bmm	Cmm	Lmm	Price - ₹	
COM-5.5	5.5	15.5	10.5	4.4 4.5	100	103.00
COM-6	6	16	10.5	4.4 5	106	103.00
COM-7	7	17	12	4.5 5.4	116	106.00
COM-8	8	18	13.5	4.7 6	127	111.00
COM-9	9	20.6	14.5	5 6.4	136	121.00
COM-10	10	21.6	15.5	5.2 6.9	146	138.00
COM-11	11	24.6	18	5.7 7.2	156	141.00
COM-12	12	25.6	19.5	6.2 7.9	167	138.00
COM-13	13	29.2	20	6.5 8.1	176	164.00
COM-14	14	30.7	21.5	6.8 8.4	186	179.00
COM-15	15	32.7	22.5	7 8.5	196	196.00
COM-16	16	34.2	24.5	7.3 9.2	206	204.00
COM-17	17	36.2	26	7.5 9.4	216	247.00
COM-18	18	38.3	28	7.6 10.4	225	260.00
COM-19	19	40.3	29	7.8 11.4	234	275.00
COM-20	20	43.3	30	8.3 12.4	240	325.00
COM-21	21	43.8	32	8.6 12	250	363.00
COM-22	22	44.8	34	8.8 13.4	265	370.00
COM-23	23	46.9	35	9 13.6	276	403.00
COM-24	24	49.9	36	9.3 14.1	287	421.00
COM-25	25	53.4	37	9.6 14.6	297	446.00
COM-26	26	54.4	38	9.8 14.9	307	476.00
COM-27	27	56	40.5	10 15.4	317	550.00
COM-28	28	58	41.5	10.2 15.9	327	590.00
COM-29	29	59	42	10.4 16.4	337	620.00
COM-30	30	62	44	10.6 17.2	347	668.00
COM-32	32	65	48	10.8 17.4	366	724.00
COM-33	33	66	48.5	12.0 15.5	372	888.00
COM-35	35	72	53.5	13.5 17.0	450	996.00
COM-36	36	72	53.5	14.0 18.0	450	1,173.00
COM-38	38	77	57.5	14.5 19.5	461	1,395.00
COM-41	41	83	63	15.5 20.5	475	1,627.00
COM-42	42	83	63	15.5 20.5	475	1,793.00
COM-44	44	92.5	68	15.5 21.5	485	1,973.00
COM-46	46	92.5	68.5	15.5 21.5	485	2,147.00
COM-50	50	101	76.5	16.5 22.5	500	2,318.00
COM-55	55	108.5	81.5	20 30.0	670	3,401.00
COM-60	60	120	88.5	22.5 30.0	695	3,676.00
COM-65	65	120.5	88.5	22.5 30.0	695	4,135.00

INCHES COMBINATION WRENCHES



Model No	Price - ₹
COM-1/4	103.00
COM-5/16	111.00
COM-3/8	138.00
COM-7/16	141.00
COM-1/2	164.00
COM-9/16	179.00
COM-5/8	204.00
COM-11/16	247.00
COM-3/4	275.00
COM-13/16	363.00
COM-7/8	421.00
COM-15/16	446.00
COM-1	550.00
COM-1-1/16	620.00
COM-1-1/8	724.00
COM-1-1/4	1105.00

COMBINATION RING RATCHET



Model No	Amm	Bmm	Cmm	Lmm	Price - ₹
GR-6	6	13	14	6.3	390.00
GR-7	7	16.3	16.6	6.6	390.00
GR-8	8	18	18	6.5	411.00
GR-9	9	19	19	7.0	423.00
GR-10	10	21	21	8	425.00
GR-11	11	23	23	8	458.00
GR-12	12	25	26	8	465.00
GR-13	13	26	27	8.6	527.00
GR-14	14	23	30	9.1	567.00
GR-15	15	29	32	10	591.00
GR-16	16	31	33	10	640.00
GR-17	17	33	36	10	693.00
GR-18	18	35	39	10	733.00
GR-19	19	36	40	10.5	779.00
GR-21	21	42	44	13	861.00
GR-22	22	43	46	14.5	1,082.00
GR-24	24	48	52	14	1,235.00
GR-27	27	51	54	15.6	1,483.00
GR-30	30	56	60	17.5	1,854.00
GR-32	32	61	64	18	2,225.00

DOUBLE SIDE RING RATCHET

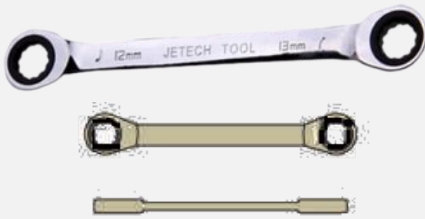

Model No	Price - ₹
GRD8-9	550.00
GRD10-11	585.00
GRD12-13	689.00
GRD14-15	776.00
GRD16-18	951.00
GRD17-19	996.00

FLEXIBLE RING RATCHET



Model No	Price - ₹
GRA-8	514.00
GRA-9	525.00
GRA-10	530.00
GRA-11	558.00
GRA-12	581.00
GRA-13	659.00
GRA-14	707.00
GRA-15	742.00
GRA-16	809.00
GRA-17	866.00
GRA-18	909.00
GRA-19	953.00
GRA-21	1,142.00
GRA-22	1,152.00
GRA-24	1,426.00
GRA-27	2,502.00
GRA-30	2,972.00
GRA-32	3,835.00

CONSTRUCTION RING RATCHET



Model No	Price - ₹
CGR10-12	724.00
CGR11-13	724.00
CGR12-14	747.00
CGR13-17	799.00
CGR14-17	799.00
CGR16-18	892.00
CGR17-19	892.00
CGR17-21	892.00
CGR19-21	892.00
CGR19-22	892.00
CGR19-24	1,412.00
CGR21-23	1,412.00
CGR21-24	1,412.00
CGR21-26	1,412.00
CG622-24	1,412.00
CGR24-27	1,652.00
CGR27-30	2,105.00
CGR30-32	2,195.00



COMBINATION PLIERS (ECONOMY)

Model No	Amm	Bmm	Cmm	Lmm	Price - ₹
PL-14-6	20	55	10	173	270.00
PL-14-7	20	55	10	200	350.00
PL-14-8	20	55	10	250	380.00



COMBINATION PLIERS

Model No	Amm	Bmm	Cmm	Lmm	Price - ₹
TPG-6 6"	23	34	12	165	407.00
TPG-7 7"	24.5	36	14	190	442.00
TPG-8 8"	27.5	43	15	212	495.00



COMBINATION PLIERS (PRO)

Model No	Amm	Bmm	Cmm	Lmm	Price - ₹
TP-6	22	24	12.5	170	645.00
TP-7	24	39	13	195	689.00
TP-8	28	43	14.5	215	762.00



LONG NOSE PLIERS (ECONOMY)

Model No	Amm	Bmm	Cmm	Lmm	Price - ₹
PL-01-6	20	55	10	173	270.00
PL-01-8	20	55	10	200	300.00



LONG NOSE PLIERS

Model No	Amm	Bmm	Cmm	Lmm	Price - ₹
RPG-6	17.5	55	10	173	358.00
RPG-8	20	70	10	200	418.00

LONG NOSE PLIERS (PRO)



Model No	Amm	Bmm	Cmm	Lmm	Price - ₹
RP-6	17.5	57	10	170	606.00

LONG NOSE PLIERS



Model No	Amm	Bmm	Cmm	Lmm	Price - ₹
RP-5D	14.5	43	8.5	133	438.00

AVIATION TIN SNIPS 10"



Model No	Amm	Bmm	Cmm	Price - ₹
AVS-10 Straight	60	50	250	694.00
AVS-10 Left	60	50	250	694.00
AVS-10 Right	60	50	250	694.00

VDE INSULATED PLIERS (1000 V)



Model No	Amm	Bmm	Lmm		Price - ₹
IDP-6	23	30	170	Diagonal Cotter	694.00
IRP-6	15	60	168	Roundnose Plier	694.00
ITP-8	30	52	205	Combination Plier	694.00

DIAGONAL CUTTERS



Model No	Amm	Bmm	Cmm	Lmm	Price - ₹
DP-5	17.2	25.5	10.3	138	529.00
DP-6	20.5	30	11.0	165	618.00

LONG NOSE PLIERS (PRO)

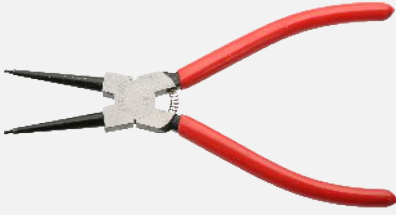

Model No	Amm	Bmm	Cmm	Lmm	Price - ₹
SRG-5A	27.5	15.5	8.5	129	339.00
SRG-7A	43.5	20	10	182	399.00
SRG-9A	55.0	25.0	10.5	234	613.00

EXTERNAL STRAIGHT CIRCLIP PLIERS

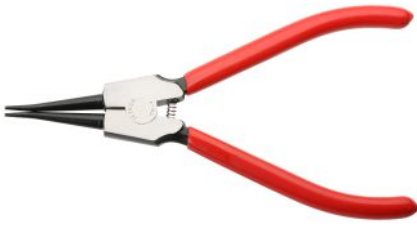

Model No	Amm	Bmm	Cmm	Lmm	Price - ₹
SRG-5B	27.5	27.5	8.5	126	339.00
SRG-7B	43.5	26.5	10	182	399.00
SRG-9B	55.0	34.0	10.5	232	613.00

INTERNAL BENT CIRCLIP PLIERS

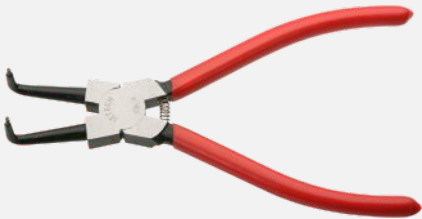

Model No	Amm	Bmm	Cmm	Lmm	Price - ₹
SRG-5C	19	15	8.5	124	339.00
SRG-7C	30	21	9.5	168	399.00
SRG-9C	40	24	10.5	217	613.00

EXTERNAL BENT CIRCLIP PLIERS

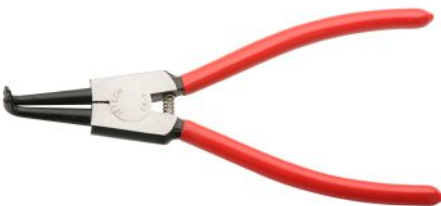

Model No	Amm	Bmm	Cmm	Lmm	Price - ₹
SRG-5D	19	21	8.0	120	339.00
SRG-7D	30	26.5	9.5	168	399.00
SRG-9D	40	34	10.5	220	613.00

MINIATURE NEEDLE NOSE PLIER 150 mm

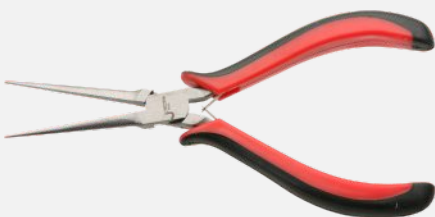

Model No	Amm	Bmm	Cmm	Lmm	Price - ₹
MP-5A	10	53	6.5	160	279.00

MINIATURE BEND NOSE PLIERS 100 mm



Model No	Amm	Bmm	Cmm	Lmm	Price - ₹
MP-5E	11	30	18	133	272.00

MINIATURE LONG NOSE PLIERS 100mm



Model No	Amm	Bmm	Cmm	Lmm	Price - ₹
MP-5R	12.5	30	6.5	127	272.00

MINIATURE FLAT NOSE PLIERS 100mm



Model No	Amm	Bmm	Cmm	Lmm	Price - ₹
MP-5L	11.5	30	7	128	272.00

MINIATURE CUTTER (FLUSHCUT) 100mm



Model No	Amm	Bmm	Cmm	Lmm	Price - ₹
DP-4D 4"				100	400.00

MINIATURE CUTTER (FLUSHCUT) 125mm



Model No	Amm	Bmm	Cmm	Lmm	Price - ₹
NP-5 5"	13.5	20	75	125	534.00

MINIATURE CUTTER (FLUSHCUT) 125mm



Model No	Amm	Bmm	Cmm	Lmm	Price - ₹
NP-5S	13.0	20	75	128	495.00

PLASTIC CUTTING PLIER (FLUSHCUT) 150mm



Model No	Amm	Bmm	Cmm	Lmm	Price - ₹
PP-6S	18.0	29	10	155	537.00

CABLE CUTTER



Model No		Price - ₹
CC-6	6" Cable Cutter	390.00
CC-8	8" Cable Cutter	487.00
CC-10	10" Cable Cutter	632.00
CC-14	14" Cable Cutter	1,072.00
CC-18	18" Cable Cutter	1,257.00
CC-24	24" Cable Cutter	1,570.00
CC-36	36" Cable Cutter	2,903.00

BOLT CUTTERS



Model No	Amm	Bmm	Cmm	Lmm	Price - ₹
BC-200					490.00
BC-300	22	55	5.5	320	953.00
BC-350	28	60.5	6.8	375	1,128.00
BC-450	32	70	7.5	465	1,306.00
BC-600	35	85	9.5	635	1,736.00
BC-750	40	97	11	790	2,422.00
BC-900	41	109	12.5	935	2,958.00
BC-1050	45	120	14	1105	4,437.00

MULTIFUNCTION WIRE STRIPPER

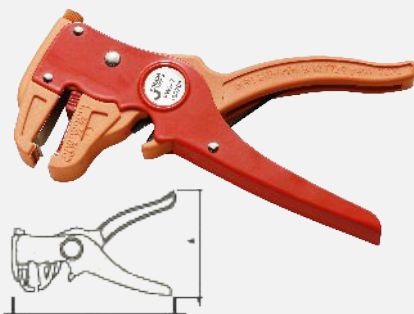

Model No	Amm	Lmm	Price - ₹
FWS-7	85	170	539.00

STEEL ANGLE SQUARE (TRISQUARE)



Model No	Amm	Bmm	Lmm	Price - ₹
AS-200	36.1	1.0	200	337.00
AS-300	36.1	1.0	300	488.00
AS-500	36.1	1.0	500	687.00

LOCKING GRIP PLIERS



Model No	Amm	Bmm	Price - ₹
LGP-5	135	40	392.00
LGP-7	191	52	538.00
LGP-10	226	64	701.00

LONG NOSE GRIP PLIER WITH WIRE CUTTER



Model No	Amm	Bmm	Price - ₹
LNP-6	167	39	557.00
LNP-9	227	51	664.00

WELDING CLAMP PLIERS



Model No	Amm	Bmm	Price - ₹
WCP-9	225	66	1070.00

CHAIN TYPE LOCKING PLIERS



Model No	Amm	Bmm	Price - ₹
LCC-10	227	55	1460.00

SHEET METAL GRIP PLIERS



Model No	Amm	Lmm	Price - ₹
SMP-8	209	60	741.00

C- CLAMP LOCKING PLIER WITH SWIVEL JAWS



Model No	Amm	Bmm	Cmm	Lmm	Price - ₹
CGP-11	281	140	71	90	1,100.00

SPIRIT LEVEL



Model No	Amm	Bmm	Lmm	Price - ₹
LVS-300mm	50	20	300	419.00
LVS-450mm	50	20	450	504.00
LVS-600mm	50	20	600	586.00
LVB-1500	60	23	600	1,764.00
LVB-1800	60	23	900	2,051.00
LVM400H				624.00
LVM600H				906.00
LVM1200H				1437.00

STAR DOUBLE END BITS



Model No	Amm	Bmm	Lmm	Price - ₹
PH2-25	#2	6.35	25	18.00
PH2-45	#2	6.35	45	28.00
PH2-50	#2	6.35	50	31.00
PH2-65	#3	6.35	65	33.00
PH2-110	#2	6.35	110	55.00
PH2-150	#2	6.35	150	74.00
PH2-200	#2	6.35	200	84.00
PH2-300	#2	6.35	300	108.00
PH3-100	#3	6.35	100	51.00

STAR SINGLE END BITS



Model No	Amm	Bmm	Lmm	Price - ₹
AR-2.5-50	#0	6.35	50	46.00
AR-3.0-50	#0	6.35	50	44.00
AR-3.0-70	#1	6.35	70	53.00
AR-4.5-50	#2	6.35	50	40.00
AR-4.5-70	#2	6.35	70	48.00

STAR SINGLE END INSERT BITS



Model No	Amm	Bmm	Lmm	Price - ₹
PH0-25	#0	6.35	25	17.00
PH1-25	#1	6.35	25	17.00
PH2-25	#2	6.35	25	17.00
PH3-25	#3	6.35	25	17.00
PH3-50	#3	6.35	25	17.00

SLOTTED INSERT BITS



Model No	Amm	Bmm	Lmm	Price - ₹
SL 4-100	0.7-4	6.35	25	56.00
SL 5-100	0.9-5	6.35	25	56.00
SL 6-100	1.1-6	6.35	25	60.00
PZ1-25				18.00
PZ2-25				18.00
PZ3-25				18.00

ALLEN BITS



Model No	Amm	Bmm	Lmm	Price - ₹
HX1.5	1.5	6.35	50	40.00
HX1.5-50	1.5	6.35	50	40.00
HX2.50	2	6.35	50	40.00
HX2.5-50	2	6.35	50	40.00
HX3-50	3	6.35	50	40.00
HX4-50	4	6.35	50	40.00
HX5-50	5	6.35	50	40.00
HX6-50	6	6.35	50	40.00
HX4-75	4	6.35	75	48.00
HX5-75	5	6.35	75	48.00
HX6-75	6	6.35	75	48.00
HX4-100	4	6.35	100	60.00
HX5-100	5	6.35	100	60.00
HX4-150	5	6.35	150	76.00
HX5-150	5	6.35	150	76.00

MAGNETIC NUT RUNNERS



Model No	Amm	Bmm	Pmm	Lmm	Price - ₹
MNS-6-65	11	6	25	65	94.00
MNS-7-65	13	7	25	65	94.00
MNS-8-65	13	8	25	65	94.00
MNS-9-65	14.5	9	25	65	99.00
MNS-10-65	14.5	10	25	65	99.00
MNS-11-65	16	11	25	65	99.00
MNS-12-65	17.5	12	25	65	106.00
MNS-13-65	17.5	13	25	65	106.00
MNS-14-65	20	14	25	65	123.00
MNS8-100	11	8	25	100	151.00
MNS9-100	13	9	25	100	151.00
MNS10-100	13	10	25	100	151.00
MNS11-100	14.5	11	25	100	151.00
MNS12-100	14.5	12	25	100	153.00
MNS13-100	16	13	25	100	153.00
MNS14-100	17.5	14	25	100	153.00

TORX BITS



Model No	Amm	Bmm	Lmm	Price - ₹
T10-25	10	6.35	25	19.00
T15-25	15	6.35	25	19.00
T20-25	20	6.35	25	19.00
T25-25	25	6.35	25	19.00
T27-25	27	6.35	25	19.00
T30-25	30	6.35	25	19.00
T40-25	40	6.35	25	19.00
FT10-50	10	6.35	50	40.00
FT15-50	15	6.35	50	40.00
FT20-50	20	6.35	50	40.00
FT25-50	25	6.35	50	40.00
FT27-50	27	6.35	50	40.00
FT30-50	30	6.35	50	40.00
FT40-50	40	6.35	50	40.00
FT10-75	10	6.35	75	52.00
FT15-75	15	6.35	75	52.00
FT20-75	20	6.35	75	52.00
FT30-75	30	6.35	75	52.00
FT40-75	40	6.35	75	52.00

BITS-32PCS



Model No	Content mm	Price - ₹
BITS32	32 PCS Bit Set ⊖ Si3 SL4 SL5 SL6 ⊕ Ph0 PH1X1 PH2X3 Ph3 ⊕ PZ0 PZ1X2 PZ2X2 Pz3 ⊗ 8 10 15 20 25 27 30 40 ⊗ 1.5 2 2.5 3 4 5 5.5 6 ● 1pcs Bit Holder	704.00

1/2" DRIVE SOCKETS (HEX)



Model No	Amm	Bmm	Cmm	Pmm	Lmm	Price - ₹
SK1/2-8	21.8	13	8	14	38	80.00
SK1/2-9	21.8	14	9	14	38	80.00
SK1/2-10	21.8	15	10	15	38	80.00
SK1/2-11	21.8	16.6	11	15	38	80.00
SK1/2-12	21.8	18	12	14	38	80.00
SK1/2-13	21.8	19	13	14	38	80.00
SK1/2-14	21.8	20.5	14	13.5	38	85.00
SK1/2-15	21.8	21.8	15	13	38	85.00
SK1/2-16	21.8	21.8	16	14	38	85.00
SK1/2-17	21.8	23.8	17	14	38	85.00
SK1/2-18	25.8	25.8	18	14	38	88.00
SK1/2-19	28.8	28.8	19	18	38	88.00
SK1/2-20	27.8	27.8	20	19	38	99.00
SK1/2-21	28.8	28.8	21	19	38	99.00
SK1/2-22	29.8	29.8	22	18	38	110.00
SK1/2-23	31.8	31.8	23	18	38	128.00
SK1/2-24	32	32	24	18	38	128.00
SK1/2-25	33.8	33.8	25	17	40	158.00
SK1/2-26	33.8	33.8	26	19	42	158.00
SK1/2-27	35.8	35.8	27	21.5	42	179.00
SK1/2-28	37.8	37.8	28	18	42	207.00
SK1/2-29	37.8	37.8	29	18	42	207.00
SK1/2-30	39.8	39.8	30	20	43	243.00
SK1/2-32	41.8	41.8	32	22	45	253.00

1/2" DRIVE DEEP SOCKETS (HEX)



Model No	Amm	Bmm	Cmm	Pmm	Lmm	Price - ₹
SK1/2-D8	22	13	8	20	77	150.00
SK1/2-D10	22	16.5	10	25	77	150.00
SK1/2-D11	22	17	11	26	77	150.00
SK1/2-D12	22	18.5	12	26	77	150.00
SK1/2-D13	22	19.5	13	26	77	150.00
SK1/2-D14	22	20.5	14	35	77	150.00
SK1/2-D15	22	21.5	15	35	77	150.00
SK1/2-D16	22	22	16	35	77	150.00
SK1/2-D17	22	24	17	36	77	150.00
SK1/2-D18	24	26	18	38	77	160.00
SK1/2-D19	24	26	19	38	77	160.00
SK1/2-D20	24	28	20	37	77	184.00
SK1/2-D21	26	28	21	37	77	184.00
SK1/2-D22	26	30	22	37	77	201.00
SK1/2-D23	28	32	23	32	77	221.00
SK1/2-D24	28	32	24	35	77	227.00
SK1/2-D27	31	27	27	34	77	307.00
SK1/2-D30	36	30	30	38	77	458.00
SK1/2-D32	36	32	32	38	77	539.00



1/2" DRIVE ALLEN SOCKETS

Model No	Amm	Bmm	Pmm	Lmm	Price - ₹
HX1/2 4-100	22	4	20	58	215.00
HX1/2 5-100	22	5	20	58	215.00
HX1/2 6-100	22	6	20	58	215.00
HX1/2 8-100	22	8	20	58	215.00
HX1/2 10-100	22	10	20	58	215.00



1/2" DR IMPACT SOCKET

Model No	Amm	Bmm	Lmm	Price - ₹
FK1/2-8	25	8	38	152.00
FK1/2-10	25	10	38	152.00
FK1/2-11	25	11	38	152.00
FK1/2-12	25	12	38	152.00
FK1/2-13	25	13	38	152.00
FK1/2-14	25	14	38	152.00
FK1/2-15	30	15	40	210.00
FK1/2-16	30	16	40	210.00
FK1/2-17	30	17	40	211.00
FK1/2-18	30	18	40	212.00
FK1/2-19	30	19	40	212.00
FK1/2-21	30	21	40	212.00
FK1/2-22	32	22	40	261.00
FK1/2-23	34	23	40	266.00
FK1/2-24	34	24	40	297.00
FK1/2-27	39	27	43	333.00
FK1/2-29	40	29	43	367.00
FK1/2-30	42	30	45	411.00
FK1/2-32	43	32	45	443.00

1/2" RATCHET WRENCH

Model No	Amm	Bmm	Cmm	Lmm	Price - ₹
RT 1/2	19	41	50	247	968.00



1/2" DR HEX-BIT UNIVERSAL JOINT FOR IMPACT SOCKET

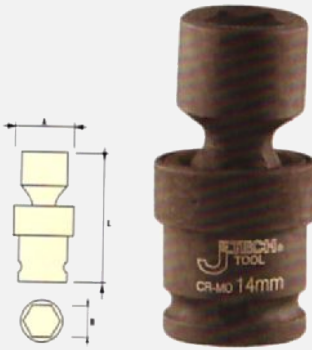

Model No	Amm	Bmm	Lmm	Price - ₹
FUJ 1/2-12	28	19.0	66	646.00
FUJ 1/2-14	28	22.0	66	646.00
FUJ 1/2-17	28	26.0	66	646.00
FUJ 1/2-18	28	26.0	66	672.00
FUJ 1/2-19	28	26.0	66	685.00
FUJ 1/2-24	28	34.0	66	744.00

1/2" CALABASH HANDLE RATCHET WRENCH



Model No	Amm	Bmm	Cmm	Lmm	Price - ₹
RT 1/2	19	41	50	247	968.00
RTS 1/2	39.5	33.5	36	240	1539.00
RTH 1/2					1539.00

SOCKETS ACCESSORIES

Model No	Content	Price - ₹
EB1/2-3"	1/2" DR EXTENSION BAR 3"	149.00
EB1/2-5"	1/2" DR EXTENSION BAR 5"	189.00
EB1/2-10"	1/2" DR EXTENSION BAR 10"	328.00
UJ1/2	1/2" DR UNIVERSAL JOINT	270.00
SB1/2	1/2" DR SLIDING BAR	337.00
FH1/2-10	1/2" DR FLEXIBLE HANDLE	847.00
FH1/2-15	1/2" DR FLEXIBLE HANDLE	869.00
OH1/2	1/2" DR FLEXIBLE HANDLE	403.00

1/4" DRIVE SOCKETS (HEX)



Model No	Amm	Bmm	Cmm	Pmm	Lmm	Price - ₹
SK1/4-4	7	4	9	5	25	32.00
SK1/4-4.5	12	7.5	4.5	11	25	32.00
SK1/4-5	12	8	5	9	25	32.00
SK1/4-5.5	12	9	5.5	9	25	32.00
SK1/4-6	12	9.5	6	10.5	25	32.00
SK1/4-7	12	11	7	11.5	25	32.00
SK1/4-8	12	12	8	11.5	25	32.00
SK1/4-9	14	14	9	10	25	32.00
SK1/4-10	14	14	10	12	25	36.00
SK1/4-11	14	16	11	10	25	38.00
SK1/4-12	14	17	12	10	25	41.00
SK1/4-13	14	18	13	12	25	45.00
SK1/4-14	15	20	14	10	25	51.00

1/4" DRIVE DEEP SOCKETS (HEX)



Model No	Amm	Bmm	Cmm	Pmm	Lmm	Price - ₹
SK1/4-D4	12	7	4	11	50	59.00
SK1/4-D4.5	12	7.5	4.5	11	50	59.00
SK1/4-D5	12	8	5	11	50	59.00
SK1/4-D5.5	12	9	5.5	11	50	59.00
SK1/4-D6	12	9.5	6	12	50	59.00
SK1/4-D7	12	11	7	25	50	59.00
SK1/4-D8	12	12	8	26	50	62.00
SK1/4-09	14	13.5	9	22	50	62.00
SK1/4-010	15	15	10	26	50	66.00
SK1/4-D11	16	16	11	36	50	83.00
SK1/4-D12	17	17	12	25	50	86.00
SK1/4-013	18	18	13	24	50	91.00
SK1/4-014	20	20	14	26	50	104.00

1/4" DRIVE ALLEN SOCKET

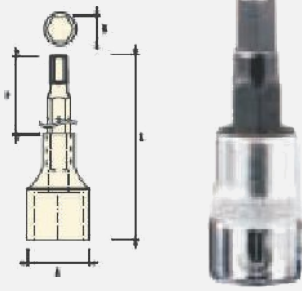

Model No	Amm	Bmm	Pmm	Lmm	Price - ₹
HX1/4 3	12	3	20	38	86.00
HX1/4 4	12	4	20	38	85.00
HX1/4 5	12	5	20	38	85.00
HX1/4 6	12	6	20	38	85.00
HX1/4 8	12	8	20	38	98.00

1/4" RATCHET WRENCH



Model No	Amm	Bmm	Cmm	Lmm	Price - ₹
RT 1/4	13	26	28	137	627.00

1/4" CALABASH HANDLE RATCHET WRENCH



Model No	Amm	Bmm	Cmm	Lmm	Price - ₹
RTS 1/4	24	24	24	147	938.00
RTH 1/4					938.00

SOCKETS ACCESSORIES



Model No	Content	Price - ₹
EB1/4-2"	1/4" DR. EXTENSION BAR 2"	60.00
EB1/4-4"	1/4" DR. EXTENSION BAR 4"	106.00
EB1/4-6"	1/4" DR. EXTENSION BAR 6"	120.00
UJ1/4	1/4" DR UNIVERSAL JOINT	143.00
SB1/4	1/4" DR SLIDING BAR	164.00
FH1/4-6	1/4" DR. FLEXIBLE HANDLE	304.00
WJ1/4-3/8	3/8" F X 1/4" M ADAPTER	76.00
AD1/4	1/4" DR. BIT ADAPTER 1/4" X 1/4"	40.00
DSH1/4	1/4" DR SPINNER HANDLE	165.00

3/8" DRIVE SOCKETS



Model No	Amm	Bmm	Cmm	Pmm	Lmm	Price - ₹
SK3/8-5.5	17	9	5.5	11	28	46.00
SK3/8-6	17	10	6	11	28	46.00
SK3/8-7	17	11	7	10	28	46.00
SK3/8-8	17	12.5	8	10	28	46.00
SK3/8-9	17	13.5	9	10	28	46.00
SK3/8-10	17	15	10	10	28	46.00
SK3/8-11	17	16	11	10	28	46.00
SK3/8-12	17	17	12	10	28	50.00
SK3/8-13	17	18	13	10	28	53.00
SK3/8-14	18	20	14	14.5	28	58.00
SK3/8-15	18	22	15	15	28	67.00
SK3/8-16	18	22	16	15	28	67.00
SK3/8-17	20	24	17	15	29	77.00
SK3/8-18	22	26	18	16	30	89.00
SK3/8-19	22	26	19	16	30	92.00
SK3/8-20	24	28	20	15	30	100.00
SK3/8-21	25	28	21	15	30	100.00
S63/8-22	28	30	22	15	31	109.00
SK3/8-23	26	30	23	15	31	111.00
SK3/8-24	26	32	24	16	32	123.00

3/8" DRIVE DEEP SOCKETS



Model No	Amm	Bmm	Cmm	Pmm	Lmm	Price - ₹
SK3/8-D6	17	10	6	12	63	105.00
SK3/8-D7	17	11	7	14	63	108.00
SK3/8-D8	17	12.5	8	14	63	108.00
SK3/8-D9	17	13.5	9	16.5	63	110.00
SK3/8-D10	17	14.5	10	17.5	63	110.00
SK3/8-D11	18	18	11	30	63	110.00
SK3/8-D12	18	18	12	30	63	113.00
SK3/8-D13	18	18	13	32	63	121.00
SK3/8-D14	18	20	14	31	63	125.00
SK3/8-D15	18	22	16	30	63	133.00
SK3/8-D16	18	22	16	28	63	147.00
SK3/8-D17	19	24	17	28	63	147.00
SK3/8-D18	22	26	18	30	63	155.00
SK3/8-D19	22	28	19	28	63	155.00
SK3/8-D20	24	27	20	28	63	184.00
SK3/8-D21	24	28	21	29	63	191.00
SK3/8-D22	26	30	22	25	63	196.00
SK3/8-D23	28	32	23	29	63	233.00
SK3/8-D24	28	32	24	28	63	233.00

3/8" DRIVE ALLEN SOCKET



Model No	Amm	Bmm	Pmm	Lmm	Price - ₹
HX3/8-3	18	3	18	45	110.00
HX3/8-4	18	4	18	45	110.00
HX3/8-5	18	5	18	45	110.00
HX3/8-6	18	6	18	45	110.00
HX3/8-8	18	8	18	45	117.00
HX3/8-10	18	10	18	45	122.00

3/8" RATCHET WRENCH

Model No	Amm	Bmm	Cmm	Lmm	Price - ₹
RT 3/8"	16	36	38	200	756.00



3/8" DR IMPACT SOCKET

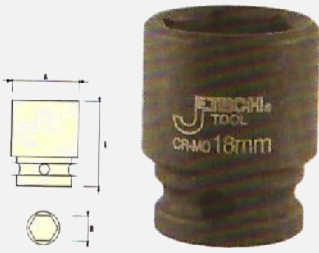

Model No	Amm	Bmm	Lmm	Price - ₹
FK3/8-6	19	11.4	63	116.00
FK3/8-7	19	12.3	63	116.00
FK3/8-8	19	13.6	63	116.00
FK3/8-9	19	14.6	63	116.00
FK3/8-10	19	15.8	63	116.00
FK3/8-11	19	17.2	63	114.00
FK3/8-12	19	18.4	63	111.00
FK3/8-13	22	19.7	63	111.00
FK3/8-14	22	20.9	63	122.00
FK3/8-15	22	22.0	63	119.00
FK3/8-16	22	24.0	63	135.00
FK3/8-17	22	24.0	63	133.00
FK3/8-18	22	25.9	63	141.00
FK3/8-19	22	27.9	63	157.00
FK3/8-20	22	28.2	63	160.00
FK3/8-21	22	30.0	63	182.00
FK3/8-22	22	31.9	63	198.00
FK3/8-24	22	34.3	63	211.00

3/8" CALABASH HANDLE RATCHET WRENCH



Model No	Amm	Bmm	Cmm	Lmm	Price - ₹
RTS 3/8"	30	30.5	32	20.5	1155.00
RTH 3/8"					1155.00

SOCKETS ACCESSORIES

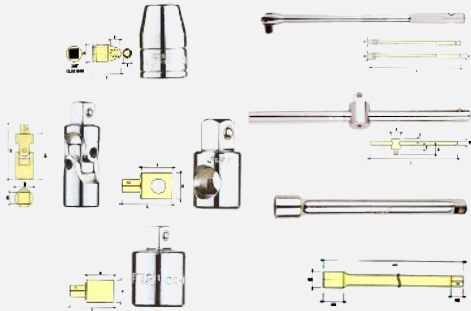

Model No	Content	Price - ₹
EB3/8-3"	3/8" DR. EXTENSION BAR 3"	104.00
EB3/8-6"	3/8" DR. EXTENSION BAR 6"	167.00
EB3/8-10"	3/8" DR. EXTENSION BAR 10"	249.00
UJ3/8	3/8" DR UNIVERSAL JOINT	179.00
SB3/8	3/8" DR SLIDING BAR	198.00
FH3/8-10	3/8" DR. FLEXIBLE HANDLE	384.00
WJ1/2-3/8		92.00
WJ3/8-1/4		56.00
WJ1/4-3/8	1/4"F X 3/8" M ADAPTER	70.00
TW3/8-1/4	3/8"F X 1/4" M 3 WAY ADAPTER	128.00
AD3/8	3/8" DR. BIT ADAPTER 3/8" X 1/4"	57.00

SCISSORS



Model No	Price - ₹
SSS -6	161.00
SSS -7	190.00

LAMINATE CUTTER KNIFE



Model No	Amm	Bmm	Cmm	Price - ₹
CF-71	23	14	150	156.00

PUNCH AND CHISEL SET



Model No	Contents		Price - ₹	
SP-13S	Crane Punch 4x120	Pin Punches	Chisels	3,281.00
	Crane Punch 5x120	3x150, 4x150, 5x150,	12x130, 15x150, 18x170	
	Drift Punch 2x100	8x150, 6x160,	Cross punch	



PIN PUNCH SET

Model No	Contents	Price - ₹
SPP-6S	mm 2x150, 3x150, 4x150, 5x150, 6x150, 8x150 The products size precision is higher than DIN standard Made of 60#CR-V, high intensity and good tenacity Chrome plated on the surface to be rust proof Standard: Q/THGS 59-2012	1,640.00



PIN PUNCHES

Model No	Contents			Price - ₹
SPP2-150	Tip width:2mm,	Hexagonal handle :9.5mm,	Length:150mm	227.00
SPP3-150	Tip width:3mm,	Hexagonal handle :9.5mm	Length:150mm	227.00
SPP4-150	Tip width :4mm,	Hexagonal handle :9.5mm	Length :150mm	227.00
SPP5-150	Tip width:5mm,	Hexagonal handle :9.5mm	Length:150mm	227.00
SPP6-150	Tip width:6mm,	Hexagonal handle :12mm,	Length:150mm	296.00
SPP8-150	Tip width:8mm,	Hexagonal handle :12mm,	Length:150mm	296.00



PRYBAR

Model No	Dia	Length	Price - ₹
PB18-400	18mm	400mm	953.00
PB20-600	18mm	600mm	1,434.00
PB22-800	22mm	800mm	2,252.00
PB22-1000	22mm	1000mm	2,925.00
P825-1500	25mm	1500mm	4,689.00



WRECKING BAR

Model No	Size	Price - ₹
VVB18-400	18X400mm	1,103.00
WB18-600	18X600mm	1,536.00
WB20-1000	20x1000mm	2,481.00



CHISELS

Model No	Amm	Bmm	Price - ₹
SGC12-130	130	12	227.00
SGC15-150	150	15	313.00
SGC18-170	170	18	427.00
SGC20-200	200	20	596.00
SGC22-250	250	22	828.00
SGC25-300	300	25	1,039.00

SCRAPER



Model No	Price - ₹
A11- CSK 3mmx90mm Blade	478.00

ANTI-STATIC BRUSH WITH STRAIGHT HANDLE



Model No	Price - ₹
ASB-S	118.00

Multi-Function Trolley



- Standard: QB/T 3006-2004
- Thickness of the red steel plate 1.5mm which makes the cabinet solid and strong.
- Plastic Spray surface. mill finish paint. rustproof ability is very strong.
- Two wheel locks strong and durable.

Model No	Amm	Bmm	Lmm	Price - ₹
RC-3	685	470	685	9,188.00

Tool Trolley With 6 Drawers



- Standard: QB/T 4400/2012
- The body is made of cold-rolled plate. thickness 1.2mm, strong and solid.
- Use TPR universal wheel with two brake, better than rubber wheel and nylon wheel in market, move more flexible.
- Good in bearing, skid resistance, abrasive resistance, and temperature tolerance.
- Double ball slid design, slipping smoothly and no noise.
- Combination lock, more solid and security.
- Plastic Spray surface, mill finish paint, rustproof ability is very strong.

Model No	Amm	Bmm	Lmm	Price - ₹
RC-6	700	460	680	36,915.00

Tool Trolley With 7 Drawers



- Standard: QB/T 3006/2008
- The body is made of cold-rolled plate. thickness 1.2mm, strong and solid.
- Use TPR universal wheel with two brake, better than rubber wheel and nylon wheel in market, move more flexible.
- Good in bearing, skid resistance, abrasive resistance, and temperature tolerance.
- Double ball slid design, slipping smoothly and no noise.
- Combination lock, more solid and security.
- Plastic Spray surface, mill finish paint, rustproof ability is very strong.

Model No	Amm	Bmm	Lmm	Price - ₹
RC-7	865	455	680	40,347.00



Tool Trolley With 9 Drawers

- Standard: QB/T 3006/2008
- The body is made of cold-rolled plate. thickness 1.2mm, strong and solid.
- Use TPR universal wheel with two brake, better than rubber wheel and nylon wheel in market, move more flexible.
- Good in bearing, skid resistance, abrasive resistance, and temperature tolerance.
- Double ball slid design, slipping smoothly and no noise.
- Combination lock, more solid and security.
- Plastic Spray surface, mill finish paint, rustproof ability is very strong.

Model No	Amm	Bmm	Lmm	Price - ₹
RC-9	860	460	1040	71,550.00



SET OF TOOL TRAYS (without trolley)

Model No	Contents	Price - ₹
SK 1/4-64C	64 PCS 1/4" DR Metric Socket Set	5416.00
SK 1/2-27C	27 PCS 1/2" DR Metric Socket Set	6080.00
SK 3/8-32C	32 PCS 3/8" DR Metric Socket Set	4452.00
OFSF-10	5 PCS Mirror Finish Double Ring Wrench	3135.00
OWSF-10C	10 PCS Mirror Finish Double Ring Wrench	3438.00
GR-14C	14 PCS Gear Wrench Set	8046.00
COMF-8C	8 PCS Mirror Finish Combination Wrench Set	2910.00
COMF-29C	29 PCS Mirror Finish Combination Wrench Hex Key Set	3811.00
F-5C	5 PCS File Set	1910.00
TP-6C	6 PCS T Type Hex Key Set	1870.00
RP-4C	4 PCS Plier Set	3001.00
SR-4C	4 PCS Snap Ring Plier Set	2279.00
ST-13C	13 PCS Softgrip Screwdriver Set	1720.00
AW-5C	5 PCS Adjustable Wrench & Plier Set	2910.00
BO-1C	1 Empty Tray For Screw Storage	410.00
TOTAL		48,478.00



64 PCS 1/4" Dr METRIC SOCKET SET

Model No	Contents	Price - ₹
SK1/4-64C	SK1/4-64C 64 PCS 1/4" DR Metric Socket Set	5,416.00
13pcs	1/4"Socket(mm) 4,4.5,5.5,6,7,8,9,10,11,12,13	
12pcs	1/4" Deep Socket(mm) 4,4.5,5.5,6,7,8,9,10,11,12,13,14	
23pcs	25mm bits T:8,10,15,20,25,30,40, PZ:1,2,3	
	HEX(mm):3,4,5,6,8,10 PH:1,2,	
	SL(mm):4,5,6,8	
8pcs	1/4 bits SL(mm):3,4,5,6, PH:1,2,3	
8pcs	1/4 softgrip ratchet wrench	
	1/4 spinner handle, 1/4 extension	
	bar 2",4",6"1/4 universal, 1/4 sliding, 1/4 bit adapter	

27PCS 1/2" Dr METRIC SOCKET SET

Model No	Price - ₹
SK 1/2-27C	PCS 1/2" DR Metric Socket Set
15 pcs	1/2" Socket(mm) 8 10 11 12 13 14 15 16 17 18 19 21 22 24 27 30 32
8 pcs	1/2" Deep Socket(mm) 10 14 17 19 22
9 pcs	1/2 softgrip Ratchet Wrench
	1/2 Socket Joint(hole 1/2 - head 3/8)
	1/2 Universal 1/2 Extension bar 5", 10"



32PCS 3/8" Dr METRIC SOCKET SET



Model No		Price - ₹
SK3/8-32C	32PCS 3/8" DR Metric Socket Set	4,452.00
15 pcs	3/8" Socket(mm)8 10 11 12 13 14 15 16 1718 19 21 22 24	
8 pcs	3/8" Deep Socket(mm)10 14 17 19 22	
9 pcs	3/8 softgrip Ratchet Wrench	
	3/8Socket Joint(hole 1/2-head 3/8)	
	3/8 Universal,3/8bit adapter,3/8	
	tri function socket joint(hole3/8-	
	head1/4), 3/8socketjoint(head3/8)a	

10PCS MIRROR FINISH DOUBLE RING WRENCH



Model No		Price - ₹
OWSF-10C	10PCS Mirror Finish Double Ring Wrench	3,135.00
2pcs	Mirror Finish double ring wrench(mm) 6x7,8x10,10x12,11x13 12x14,14x1717x19,19x21 21x23,24x27	

10PCS MIRROR FINISH DOUBLE OPEN WRENCH



Model No		Price - ₹
OWSF-10C	10 PCS Double Open Mirror Finish	3,438.00
2pcs	Gear wrench(mm) 13,14	
2Pcs	Mirror Finish Double(mm) 6x7,8x10,10x12,11x13,12x14 22X24,24x27,30x32.	
	Double Ring Wrench	

14PCS GEAR WRENCH SET



Model No		Price - ₹
GR-14C	1 4 PCS Gear wrench set	8,046.00
2pcs	Gear wrench(mm) 13,14	
2Pcs	Mirror Finish Double(mm) 6x7,8x10,10x12,11x13,12x14 22X24,24x27,30x32.	
	Double Ring Wrench	

8PCS MIRROR FINISH COMBINATION WRENCH SET



Model No		Price - ₹
COMF-8C	Mirror Finish Combination Wrench Set	2,382.00
8pcs	Mirror finish combination wrench (mm) 6,7,8,20,21,22,23,24	



4PCS PLIER SET

Model No		Price - ₹
RP-4C	4pcs PlierSet	3,001.00
4pcs	8" combination plier 6" diagonal plier 6" diagonal cutting plier 6" long nose plier	



29PCS MIRROR FINISH COMBINATION WRENCH SET, HEX KEY SET

Model No		Price - ₹
COMF - 29C	29PCS Mirror Finish Combination Wrench	3,811.00
9 pcs	Hex Key Set A(mm)1.5 2 2.5 3 4 5 6 8 10	
9 pcs	Hex Key set B 10 15 20 25 27 30 40 45 50	
11 pcs	Mirror Finish Combination Wrench(mm) 9 10 11 12 13 14 15 16 17 18 19	



5PCS FILE SET

Model No		Price - ₹
F-5C	5 PCS File Set	1,910.00
5pcs	8" second flat 8" second cut half round file 8" second cut round file 8" second cut triangle file 8" second cut square	

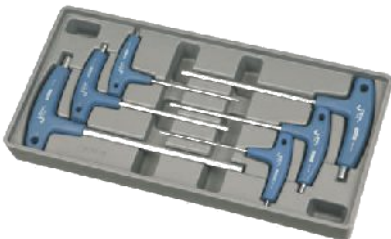

6PCS TYPE HEX KEY SET

Model No		Price - ₹
TP-6C	6PCS T Type Hex Key Set	1,870.00
14pc	sT type HEX KEY(mm):2,3,4,5,6,8	

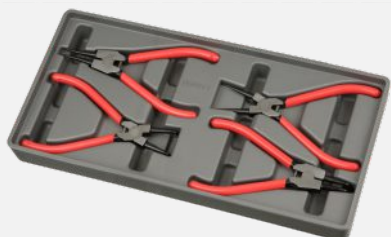

4PCS SNAP RING PLIER SET

Model No		Price - ₹
SR-4C	4PCS Snap Ring Plier Set	2,279.00
4 pcs	Internal Snap Ring Plier, External Snap Ring Plier, Bent Internal Snap Ring Plier, Bent External Snap Ring Plier	



13PCS SOFTGRIP SCREWDRIVER SET

Model No		Price - ₹
ST-13C	13PCS Soft grip Screwdriver Set	1,720.00
4 pcs	Softgrip screwdriver ⊕ #0-75 #1-75 #2-100 #3-150	
3 pcs	Softgrip screwdriver ⊖ ST4-75, ST5-75, ST6-100	
3 pcs	Precession screwdriver ⊕ Ø1.8x20 Ø 2.5x20 Ø3.0x20	
3 pcs	Precession screwdriver ⊖ Ø1.4x20 Ø 1.8x20 Ø2.5x20	



5PCS ADJUSTABLE WRENCH AND PLIER SET

Model No		Price - ₹
AW-5C	5PCS Adjustable Wrench & Plier Set	2,910.00
2 pcs	Adjustable wrench: 8" 10"	
2 pcs	6" long nose plier 6", long nose locking plier, 6" curved jaw locking	



5PCS ADJUSTABLE WRENCH AND PLIER SET

Model No		Price - ₹
BO-1C	1Empty Tray For Screw Storage	410.00



35PCS TOOL KIT ELECTRICAL TOOL SET

- Standard: Q/TKGS 15-2008
- Designed for various usage, for daily use of Electronic Engineer, Equipment Engineer, Technician etc.
- Blow case package is more solid and long life. convenience for save use.

Model No		Price - ₹
JEB-E35	ELECTRICAL TOOL SET	5,215.00
11pcs	1/4 socket(mm) 4,4.5,5,5.6,7,8,9,10,11,12,13.	
7pcs	Flat Plated Hex Key(mm) 1.5,2,2.5,3,4,5,6.	
4pcs	Line color Screwdriver (mm): #0-75, #1-100	
13pcs	6" Adjustable wrench mini Long Nose Plier, Mini Diagonal Plier 1/4 Ratchet 30W Soldering Iron Tin Solder, Adhesive Tape, 6" Wire Stripper Tweezer Curved Tweezer, Tin Adhesive, Digital Multi meter Digital Test Pencil.	



54 PCS TOOL KIT ELECTRICAL TOOL SET

- Standard: Q/TKGS 15-2008
- Designed for various usage, for daily use of Electronic Engineer, Equipment Engineer, Technician etc.
- Blow case package is more solid and long life. convenience for save use.

Model No		Price - ₹
JEB-E54	ELECTRICAL TOOL SET	6,660.00
13pcs	1/4 socket(mm) 4,4.5,5,5.5,6,7,8,9,10,11,12,13,14	
4pcs	Line color Screwdriver (mm): ⊖ ⊕ 6-40, ⊖ ⊕ 6-100	
6pcs	Precision Screwdriver (mm): ⊖ 2.5-75, ⊖ 3-100, ⊖ 3-150 ⊕ 2.5-75, ⊕ 3-100, ⊕ 3-150	
15pcs	Bits(mm): SL:4,5,6 T:10,15,20 PH: 1,2,3 HX:2,3,4,5,6,8	
16pc	6" Adjustable wrench, 6" Long Nose Pliers, 6" Diagonal Plier, 8" Wire Stripper, Cutter Knife, Tin Tweezer, Computer Brush, Digital test Pencil, Adhesive Tape, Tin Solder, 1/4 spinner Handle, 30W Soldering Iron Tin Absorber, Measuring Tape 3.5, 3.5M Measuring apes, 1/4" Spinner, 1/4" Joints	

SK 46 PCS ¼ DR SOCKET SET METRIC



Model No	Price - ₹
SK 46 PCS ¼ DR SOCKET SET MATRIC	2,560.00
<ul style="list-style-type: none"> ¼ DR 6P.T Bit Socket (mm) HX3, HX4, HX5, HX7, Hx8 ¼ DR Phillips-Bit Socket (mm) PH1, PH2, Ph3 ¼ DR PZ Drives-Bit Socket (mm) T8, T10, T15, T20, T25, T30, T40 ¼ DR Slotted-Bit Socket (mm) SL4.0, SL5.5, SI7 ¼ DR 6P.T Socket (mm) 4, 4.5, 5, 6, 7, 8, 9, 10, 11, 12, 13, 14 	<ul style="list-style-type: none"> ¼ Universal Joint ¼ Softgrip Ratchet Handle ¼ Extension Bar 2" 4" ¼ Extension Bar 6"Flexible ¼ Spinner Handle ¼ Sliding Bar Flat Black Finish Hex Key 1.27B, 1.5B, 2B, 2.5B

123PCS TOOL KIT



Model No	Price - ₹
123PCS Tool set	18,363.00
10pcs	● 1/4 socket(mm) 4,5,6,7,8,9,10,11,12,13
11pcs	● 3/8 socket(mm) 9,10,11,12,13,14,15,16,17, 18,19
8pcs	● 3/8 Torque Socket(mm): 8,10,11,12,14 16,18,20
7pcs	● ½ Socket(mm): 20, 21,22,24,27,30,32
4 pcs	● ¼Deep Socket (mm):8,9,10,12
4 pcs	● 3/8 Deep Socket (mm):13,14,17,19
4 pcs	● ½ Metric Impact Socket(mm): 17,19,21,23
4 pcs	● ½ Socket(in)15/16", 1", 1-1/16", 1-1/4"
10 pcs	● ¼ Socket(in): 5/32", 3/16", 7/32", ¼", 9/32", 5/16", 11/32",3/8", 7/16", ½"
9 pcs	● 3/8 Socket(in): 3/8", 7/16", ½", 9/16", 5/8", 11/16", ¾", 13/16", 7/8"
17 pcs	25mm Bits Socket: T10,T15,T20,T25,T27,T30, T30,T40,PH 1, PH 2,PH 3. 3/8 Bits Socket:T20, T30,T40,T45,T50,T55,TT60, HEX3,HEX4, HEX5,HEX6,SL5,SL 6,PZ 2 PH1,PH2.
10 pcs	Combination wrench(mm): 8,9,10,11,12, 13,14,17,18,19
15 pcs	¼ bit adaptor,¼ softgrip ratchet wrench,3/8 softgrip ratchet wrench, ½ softgrip ratchet wrench, ¼ universal, 3/8 universal, ½ universal, ¼ extension bar 2", 3/8 extension bar 3".6", ½ extension bar 5".10", ¼ spinner handle, 3/8 spark plug 16mm, 21mm.

150PCS Tool set



Model No	Price - ₹
150PCS Tool set	25,663.00
12PCS	● Mirror finish combination wrench(mm) 8 9 10 11 12 13 14 15
3PCS	16 17 18 19
6PCS	● Gear socket wrench(mm) 8-10 12-13 17-19
6PCS	● ¼" 6P.T Deep Socket(mm) 4 5 6 7 8 9
6PCS	● 3/8" 6P.T Deep Socket(mm) 10 11 12 13 14 15
10PCS	● 1/2" 6P.T Deep Socket(mm) 10 12 13 14 17 19
11PCS	● 1/4" 6P.T Metric Socket(mm) 4 5 6 7 8 9 10 12 13
7PCS	● 3/8" 6P.T Metric Socket(mm) 9 10 11 12 13 14 15 16 17 18 19
4PCS	● 1/2" 12P.T Metric Socket(mm) 20 21 22 24 27 30 32
8PCS	● 1/2" Impact Socket(mm) 17 19 21 23
21PCS	● 3/8" Torque Socket(mm) E8 E10 E11 E12 E14 E16 E1 3/8" Torque Socket T20 T30 T40 TT45 TT50 TT55 TT60 HX3 HX4 HX5 Hx6 HX8 HX10 PH1 PH2 Ph3 SI4 SL5 SL6
7PCS	25mm Bit(mm): TT: 10 15 20 25 27 30 40
10PCS	● ¼" 6P.T Hex-Bit Socket(inch) 5/32 3/16 7/32 ¼ 9/32 5/16
9PCS	11/32 3/8 7/16 12.
4PCS	● 3/8" 6P. T Hex-Bit Socket(inch) 3/8 7/16 ½ 9/16 5/8 11/16 ¾
10PCS	13/16 7/8
15PCS	● 1/2" 12P. T Hex-Bit Socket(inch) 15/16 1 1-1/16 1-1/4
	● 10pcs flat hex key set 1.5 2 2.5 3 4 5 6 8 10 12 ¼ extension bar4" 3/8" extension bar3",6" ½"extension bar5" 10" ¼ bit adapter ¼ universal 3/8 universal ½ universal ¼ softgrip ratchet 3/8 softgrip ratchet ½ softgrip ratchet ¼ spinner handle 3/8 spark plug 16mm , 21 mm



24PCS SOCKET SET

Model No		Price - ₹
24 PCS	½" DR metric socket set	4,000.00
20pcs	½ Socket set (mm): 8 9 10 11 12 13 14 15 16 17 18 19 20 21 22 23 24 27 30 32	
4pcs	½ softgrip ratchet wrench ½ extension bar10* ½ universal ½ socket joint (hole3/8-head1/2)	



3/8" SOCKET SET WITH BITS

Model No	Contents	Price - ₹
SK3/8-46SP	46pcs 3/8 Metric Socket Set	3,091.00
20pcs	3/8 Metric Socket (mm): 5.5 6 7 8 9 10 11 12 13 14 15 16 17 18 19 20 21 22 23 24 25mm Bits HX3 HX4 HX5 HX6 HX8 Hx10	
21 pcs	T10 T15 T20 T25 T30 T40 PZ1 PZ2 Pz3 PH1 PH2 PH3 SL4 SL5 SL6	
5pcs	3/8 Quick Release Ratchet Wrench 3/8 Extension Bar 3", 6" 3/8 Universal Joint 3/8 Bit Adapter	



18PCS ELECTRIC TOOL BAG

Model No		Price - ₹
JEP-R18	18PCS ELECTRIC TOOL BAG	3,091.00
4pcs	Sg softgrip screwdriver 6x100mm #2x100mm Sg softgrip screwdriver 4x175mm #0x75mm	
7pcs	Hex key set(mm):1.5,2 2.5,3,4,5,6 Hacksaw claw Hammer , 8" Adjustable Wrench.	
7pcs	Digital Test Pencil, Measuring Tape 3MI 6" Combination Pliers, cutter Knife.	



TOOL KIT 66PCS FOR 2 WHEELER (AUTOMOBILE)

Model No		Price - ₹
JEP-R66	66 PCS ELECTRIC TOOL BAG	6,769.00
12pcs	1/4" Socket(mm):4, 4.5,5,5.5,6,7,8,9,10,11,12,13	
10pcs	3/8" Socket(mm):10,11,12,13,14,15,16,17,18,19	
18pcs	Bits(mm):SL:4 5 6 PH:1 2 3 HX: 2 3 4 5 6 8 T:10 15 20 25 27 30	
3pcs	Doble open end wrench (mm):8-10,12-14, 17-19	
2pcs	SG soft grip screwdriver(mm) 6x100mm	
7pcs	Hex keys set(mm) 1.5, 2, 2.5, 3, 4, 5, 6	
14pcs	3/8" spark plug 16",21", tri-function socket joint (hole3/8"-head1/4"), 1/4bit adapter 3/8" universal joint, 1/4", 3/8" extension bar 3", Brass wires brush, 1/4", extension bar 75, Tire pressure gauge, 9pcs feeler gauge, 6" Adjustable wrench, 6" slip-joint pliers	



TOOL BOXES

14" PORTABLE TOOL BOX

- Standard: QB/T 3006-2008
- Made of zinc phosphating steel SPCC, rustproof ability is very strong.
- Thickness of side plate 0.6mm, thickness of top plate 0.8mm.

Model No	Amm	Bmm	Lmm	Price - ₹
TB-14	90	155	355	1,141.00



17" PORTABLE TOOL BOX

- Standard: QB/T 3006-2008
- Made of zinc phosphating steel SPCC, rustproof ability is very strong.
- Thickness of side plate 0.6mm, thickness of top plate 0.8mm.

Model No	Amm	Bmm	Lmm	Price - ₹
TB-17	190	178	430	2,366.00



18" PORTABLE TOOL BOX WITH 5 TIPPING DRAWERS

- Standard: QB/T 3006-2008
- Made of zinc phosphating steel SPCC, rustproof ability is very strong.
- Thickness of side plate 0.6mm,thickness of top plate 0.8mm.

Model No	Amm	Bmm	Lmm	Price - ₹
TB-18	200	200	420	2,746.00



19" PORTABLE TOOLBOX

- Standard: QB/T 4399-2012
- Made of zinc phosphating steel SPCC, rustproof ability is very strong.
- Thickness of side plate 0.6mm, thickness of top plate 0.8mm.

Model No	Amm	Bmm	Lmm	Price - ₹
TB-19	190	180	480	2,450.00



20" PORTABLE TOOLBOX

- Standard: QB/T 3006-2008
- Thickness of side plate 0.6mm, thickness of top plate 0.8mm.

Model No	Amm	Bmm	Lmm	Price - ₹
TB-20	90	155	500	1,436.00



21" PORTABLE TOOLBOX

- Standard: QB/T 3006-2008
- Thickness of side plate 0.6mm, thickness of top plate 0.8mm.

Model No	Amm	Bmm	Lmm	Price - ₹
TB-21	230	200	500	2,873.00



TOOL BOX 3 DRAWERS

- Standard: QB/T 3006-2008
- Cylinder type clock, more security and strong.
- Plastic Spray surface, mill finish paint, rustproof ability is very strong.
- Double ball slide design, slipping smoothly.
- Plastic covered handle, towing easily.

Model No	Amm	Bmm	Lmm	Price - ₹
TC-3	270	320	670	13,339.00



TOOL BOX 6 DRAWERS

- Standard: QB/T 3006-2008
- Cylinder type clock, more security and strong.
- Plastic Spray surface, mill finish paint, rustproof ability is very strong.
- Double ball slide design, slipping smoothly.
- Plastic covered handle, towing easily.

Model No	Amm	Bmm	Lmm	Price - ₹
TC-6	382	305	660	19,970.00



PLASTIC TOOL BOX

- The box is made of enhancement PP, high grade impact resistance.
- The handle is made of ABS engineering plastic, solid and durable; baffle plate inside, convenience for separate the space.
- Drop from 3M height with 3kg load, several times, no broken.

Model No	Amm	Bmm	Lmm	Price - ₹
JB-15	385	200	145	1,220.00
JB-16	410	215	190	1,381.00
JB-18	450	245	215	1,809.00



PLASTIC TOOL BOX

- Standard: QB/T 4399-2012
- Made of zinc phosphating steel SPCC, rustproof ability is very strong.
- Thickness of side plate 0.6mm, thickness of top plate 0.8mm.

Model No	Amm	Bmm	Lmm	Price - ₹
JE-15	385	200	145	676.00
JE-16	410	215	190	969.00
JE-18	450	245	215	1,265.00